

INSTALLATION INSTRUCTIONS

LEGGEANVISNING | VERLEGEANLEITUNG | INSTRUCTIONS DE POSE |
ИНСТРУКЦИИ ПО УКЛАДКЕ | KLOJIMO INSTRUKCIJA



THE ART OF HARDWOOD FLOORING



INSTALLATION INSTRUCTIONS



THE ART OF HARDWOOD FLOORING

LEGGEANVISNING | VERLEGEANLEITUNG | INSTRUCTIONS DE POSE |
ИНСТРУКЦИИ ПО УКЛАДКЕ | KLOJIMO INSTRUKCIJA

UK/US Always store the hardwood flooring in dry conditions and do not open the cartons until just before use.

Our quality controllers have sorted and graded the parquet. Should there be any doubt concerning grading and/or visual defects, it is important that claims be made prior to the flooring being installed. For more information on Boen and Boen products, please visit: www.boen.com

N Parketten skal lagres tørt, og pakkene skal ikke åpnes før parketten skal legges.

Våre fagfolk har sortert og klassifisert parketten. Dersom det skulle være tvil om sorteringen, skal reklamasjon på sortering eller eventuelle synlige feil fremmes før parketten legges. For mer informasjon om Boen og Boen produkter, vennligst besøk: www.boen.no

DE Bitte die Ware vor der Verlegung immer trocken lagern und die Pakete erst direkt bei Verlegebeginn öffnen.

Unsere Qualitätskontrolleure haben jedes Element überprüft und sortiert. Sollten dennoch Beanstandungen bezüglich der Sortierung und/oder visueller Fehler bestehen, so ist es wichtig, uns dies vor der Verlegung mitzuteilen. Für weitere Information über Boen und Boen Produkte: www.boen.de

S Parketten ska läggas torrt och paketen ska inte öppnas förrän det ska läggas.

Vår kunniga personal har sorterat och klassificerat parketten. Där det skulle vara tvivel om sorteringen ska reklamationer på det eller eventuella andra synliga fel, påvisas innan parketten är lagd. För mer information: www.boen.se

F Stocker toujours les colis dans un local sec et ne pas les ouvrir avant la pose.

Notre personnel qualifié s'est chargé de la sélection des choix et de la vérification de la qualité de fabrication. Toutefois, il est impératif de vérifier individuellement chaque lame avant la pose afin de s'assurer du choix et/ou des défauts visuels. Pour plus d'informations: www.boen.com

I I pacchi contenenti il nostro parquet devono essere sempre collocati in un luogo asciutto e non devono essere aperti prima dell'utilizzo.

Le tavole sono tutte selezionate in base alla scelta ed esaminate dai responsabili del controllo qualità. Qualsiasi dubbio o reclamo in merito alla scelta e/o a difetti visivi va segnalato prima della posa del parquet.

ES Por favor, almacene siempre la mercancía en lugar seco y no abra los paquetes antes de la colocación.

El personal cualificado de Boen ha seleccionado y controlado la calidad de fabricación. Sin embargo, es imprescindible verificar individualmente cada lama antes de la instalación y si se encontrasen deficiencias en cuanto a la selección o se evidenciasen fallos visibles, es importante que esto se nos comuniqué antes de la colocación.

SF Aava parkettipakkaukset vasta juuri ennen asennuksen aloittamista.

Boen lautaparketti on jo tehtaalla lajiteltu ja pintakäsitelty valmiiksi asennusta varten. Kuitenkin on muistettava tarkastaa laudat ennen asennusta ja mahdollista näkyvästä vioista on huomautettava ennen parketin asennusta.

NL Steeds de pakken parket in droge omstandigheden bewaren en slechts te openen vlak voor gebruik.

Het parket wordt gesorteerd en gegradeerd door experts. Mocht er toch twijfel bestaan over gradering en/of zichtbare gebreken, dan is het zeer belangrijk klachten te melden vooraleer het parket gelegd wordt.

PL Prosimy, składować kartony z podłogą w pomieszczeniach suchych i rozpakowywać bezpośrednio przed układaniem.

Na różnych etapach procesu produkcyjnego dokonywana jest kontrola jakościowa parkietu w celu wyeliminowania wad. Mimo tego, w przypadku stwierdzenia przez Państwa widocznych wad np. uszkodzeń mechanicznych, jak również dotyczących sortowania, ważne jest aby zgłosić je do nas przed ułożeniem parkietu.

RU Паркетные доски храните в сухом помещении в оригинальной картонной упаковке, которую открывайте лишь непосредственно перед укладкой.

Наши специалисты по контролю над качеством продукции паркет сортируют и проверяют. При возникновении каких-либо сомнений относительно классификации или видимых дефектов паркета, претензий следует предъявлять еще до укладки паркета на пол.

CZ Kartony se otevírají až těsně před pokládkou.

Parkety rozřídili podle jakosti naši kontroloři. V případě pochybností o třídě jakosti anebo v případě vizuálních vad je třeba podat reklamaci před samotnou pokládkou.

TR Parke kartonlarını her zaman kuru şartlarda saklanmalıdır ve kullanılmadan önce açılmamalıdır.

Bizim kalite kontrolcülerimiz parkeyi sınıflandırmış ve not vermişlerdir. Değerlendirilmede herhangi bir şüphe ve/yada görünüm kusuru olursa, hak iddiasının parkenin monte edilmesinden önce yapılması önemlidir.

LT Kartonines parketlenčių dėžes saugokite sausose patalpose ir atidarykite tik prieš pat suklojimą.

Mūsų kokybės kontrolieriai parkentes išrūšiuoja ir patikrina. Jei kyla bet kokių abejonių dėl rūšies ar vizualių defektų, labai svarbu nusiskundimus pareikšti prieš suklojant grindis.

LV Kartona parketa dēļu kastēs uzglabājiēt sausās telpās un atveriet tikai pirms ieklāšanas.

Mūsu kvalitātes kontrolieri parketa dēļus izšķīro un pārbauda. Ja rodas jebkādas šaubas par šķiras vai vizuāliem defektiem, ļoti svarīgi par defektiem paziņot pirms grīdas ieklāšanas.

EE Parketilaudu hoidke kuivas ruumis ning tootjapakendites ja avage pakendid vahetult enne paigaldamist.

Meie parketilauad on kontrollitud ja sorteeritud. Kui on kahtlusi parketilaudade sordi osas või esineb visuaalseid defekte, esitage pretensioonid enne põranda paigaldamist.

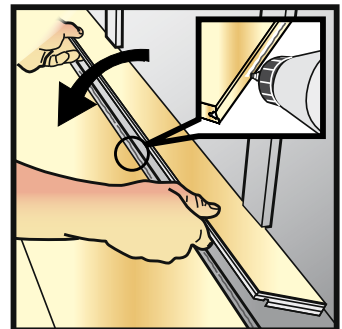
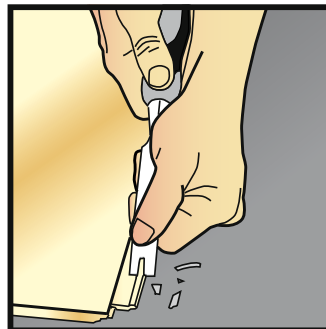
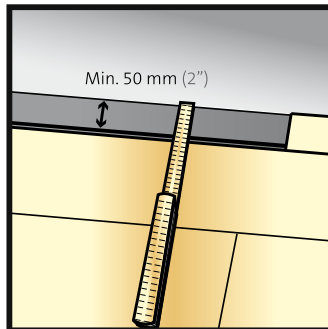
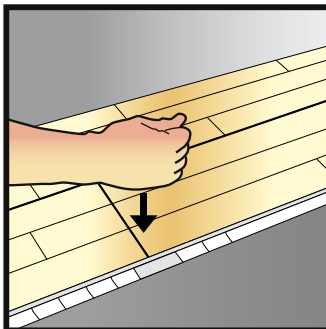
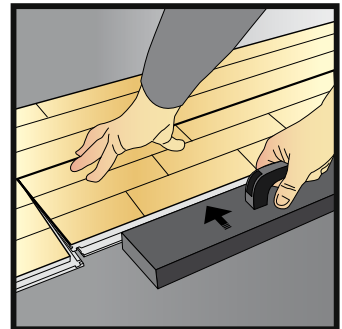
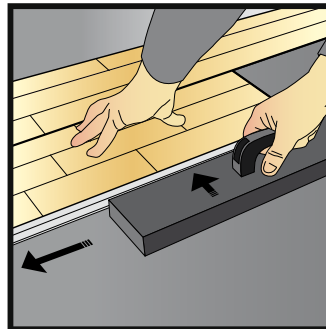
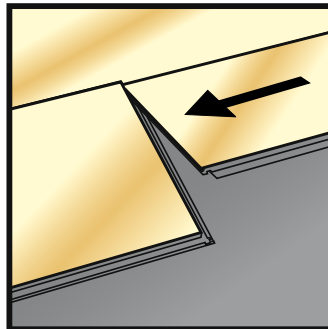
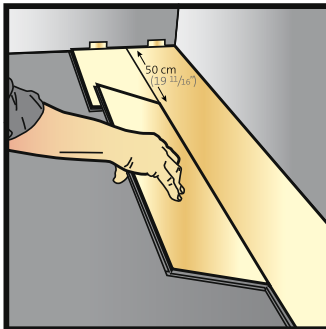
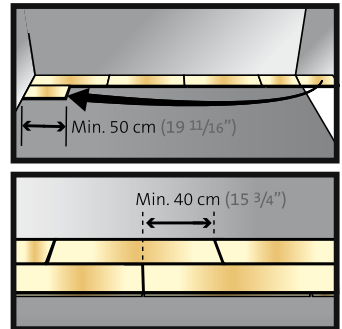
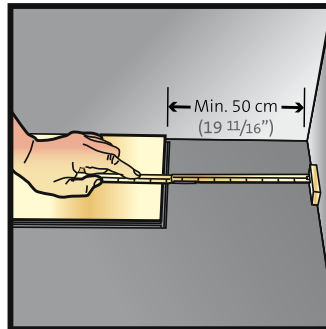
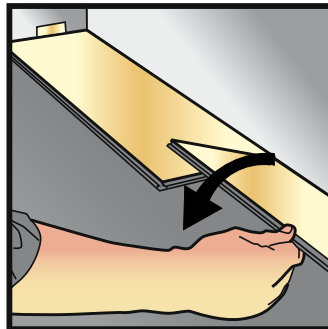
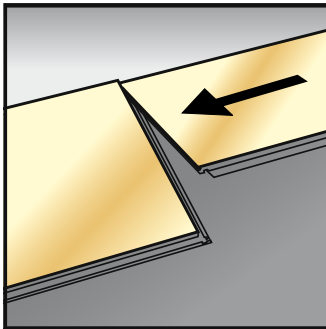
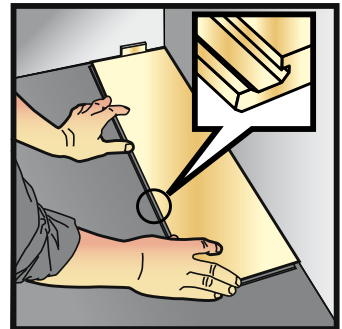
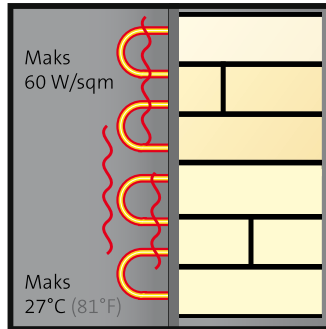
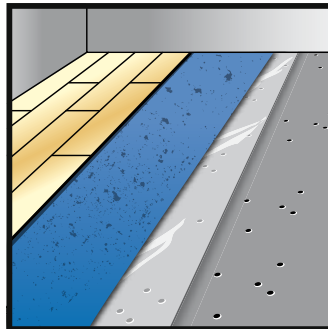
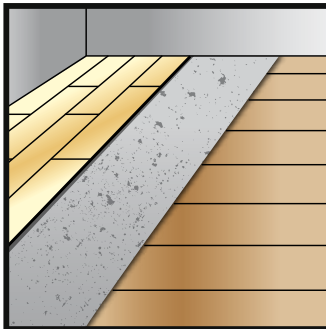
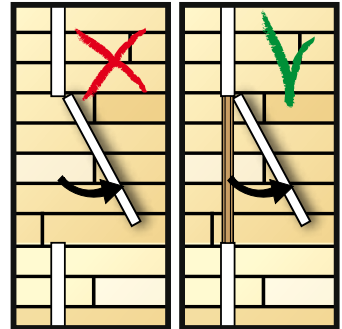
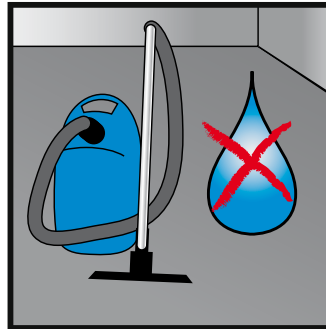
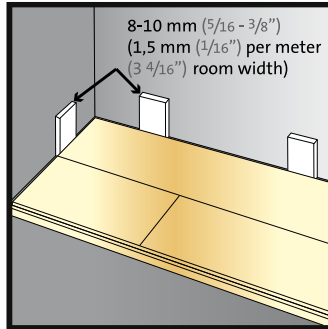
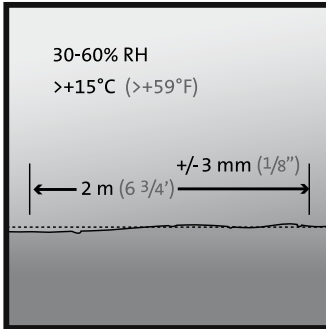

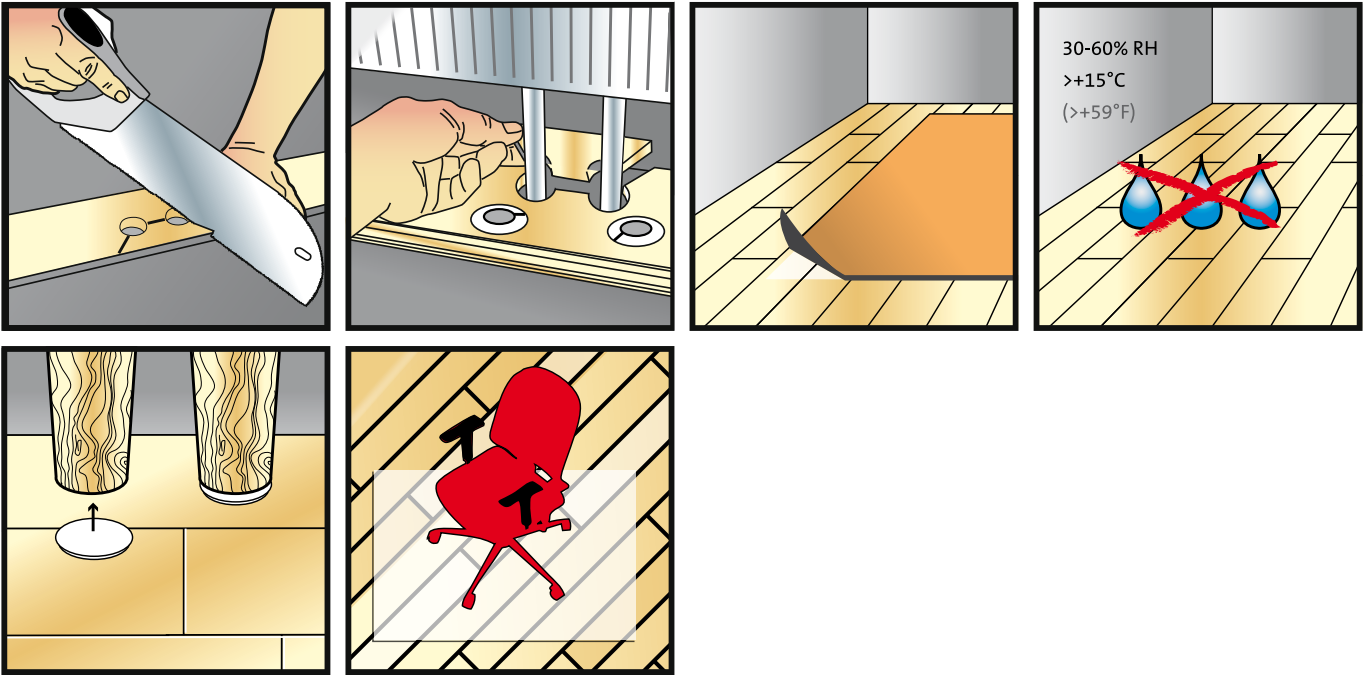

Remove/Demontage

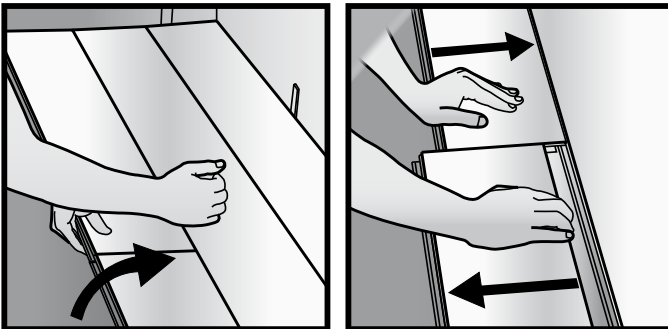

EN 14342

CE

| | |
|-------------------------------|---------------------------|
| Density: | $\geq 550 \text{ kg/m}^3$ |
| Thickness: | 14 mm |
| Reaction to fire: | Dfl-s1 |
| Emission of Formaldehyd: | E1 |
| Content of Pentachlorophenol: | not detected |

BOEN  **PRESS**

